

REVISIONS			
REV	DESCRIPTION	DATE	APPROVED

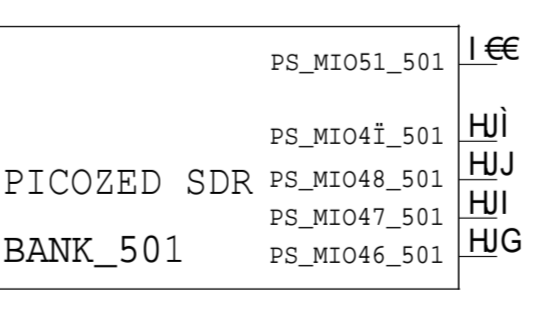
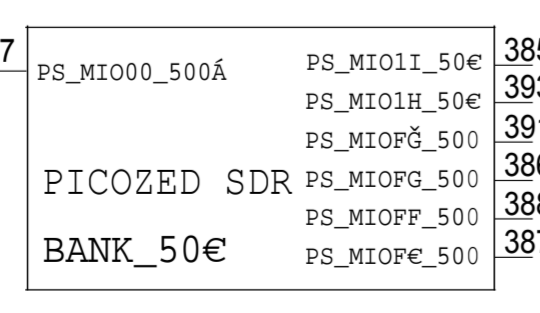
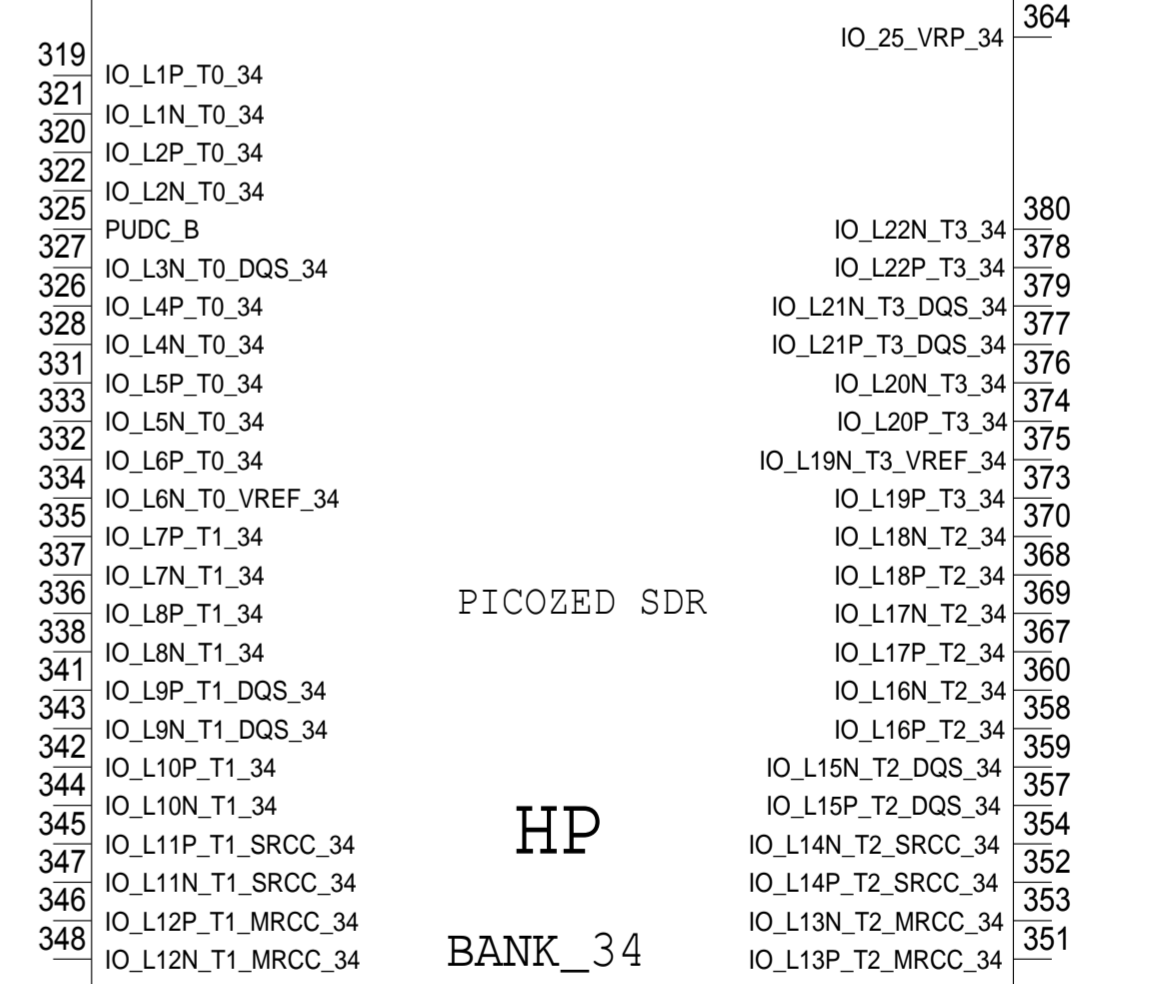
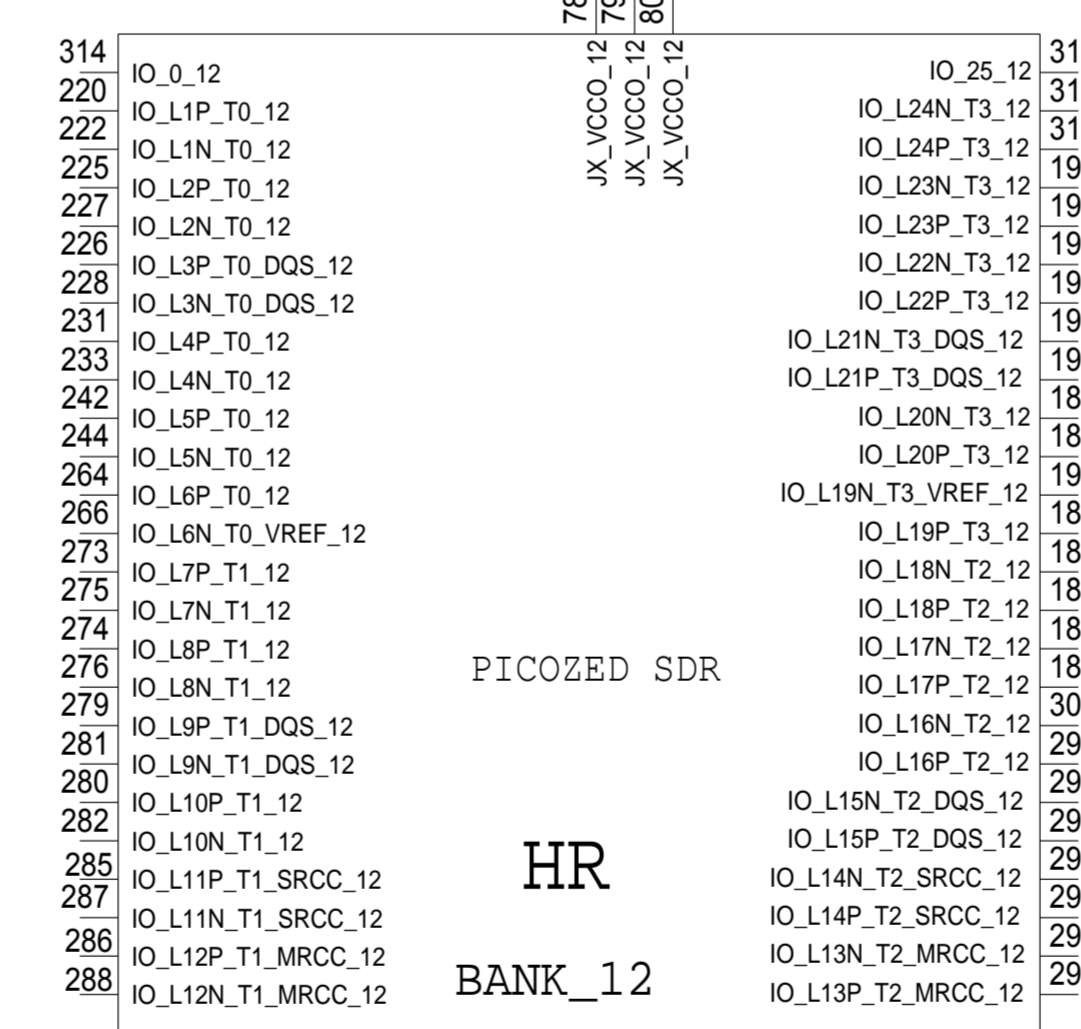
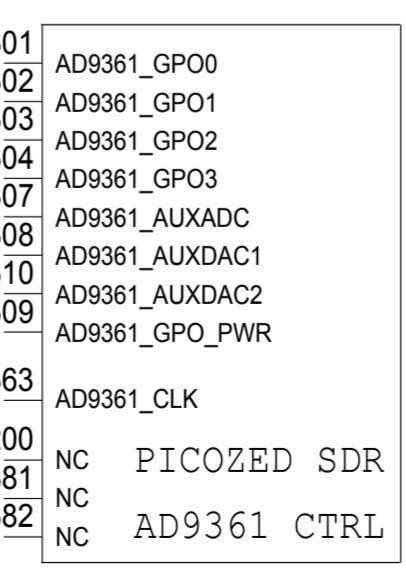
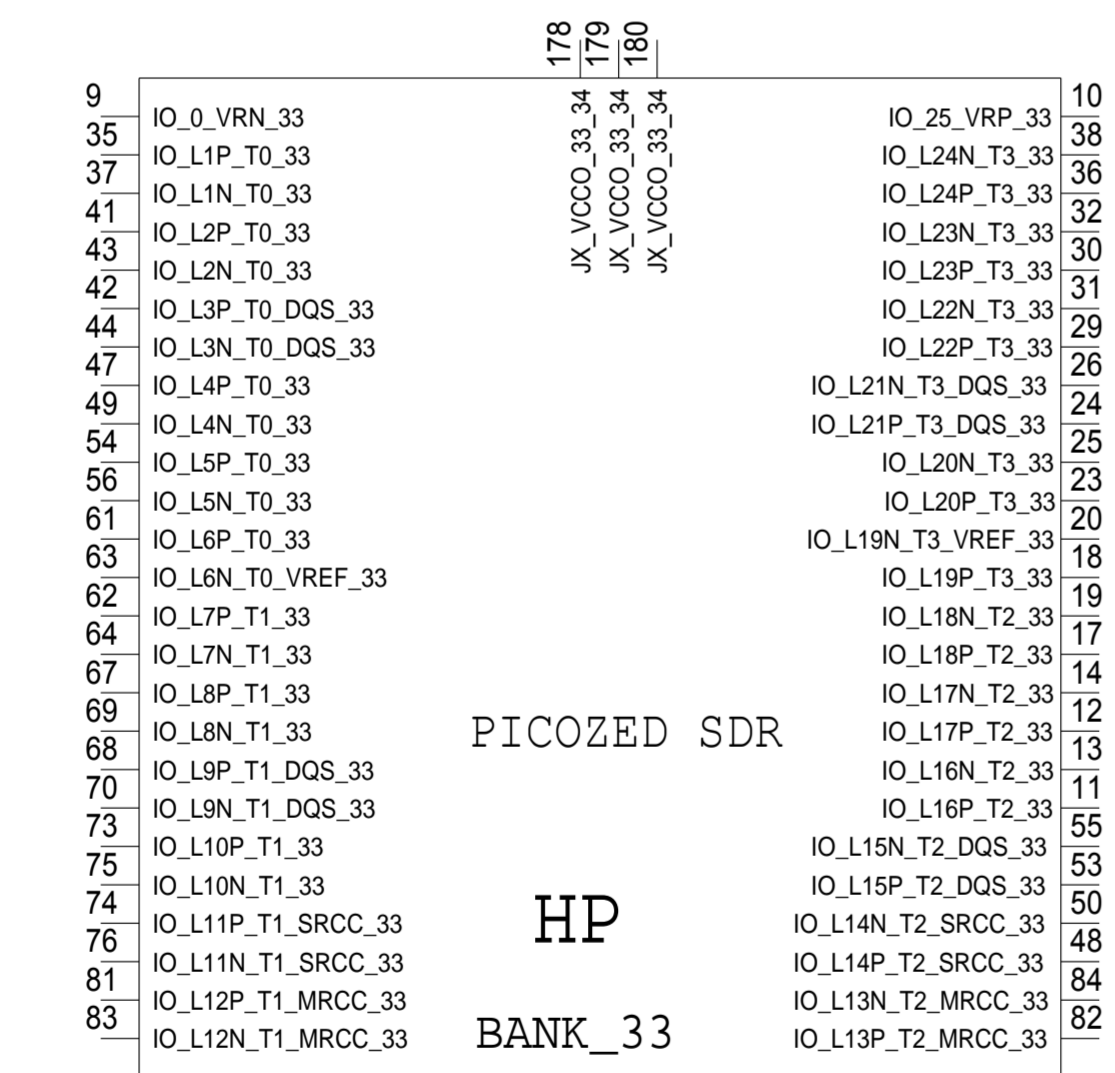
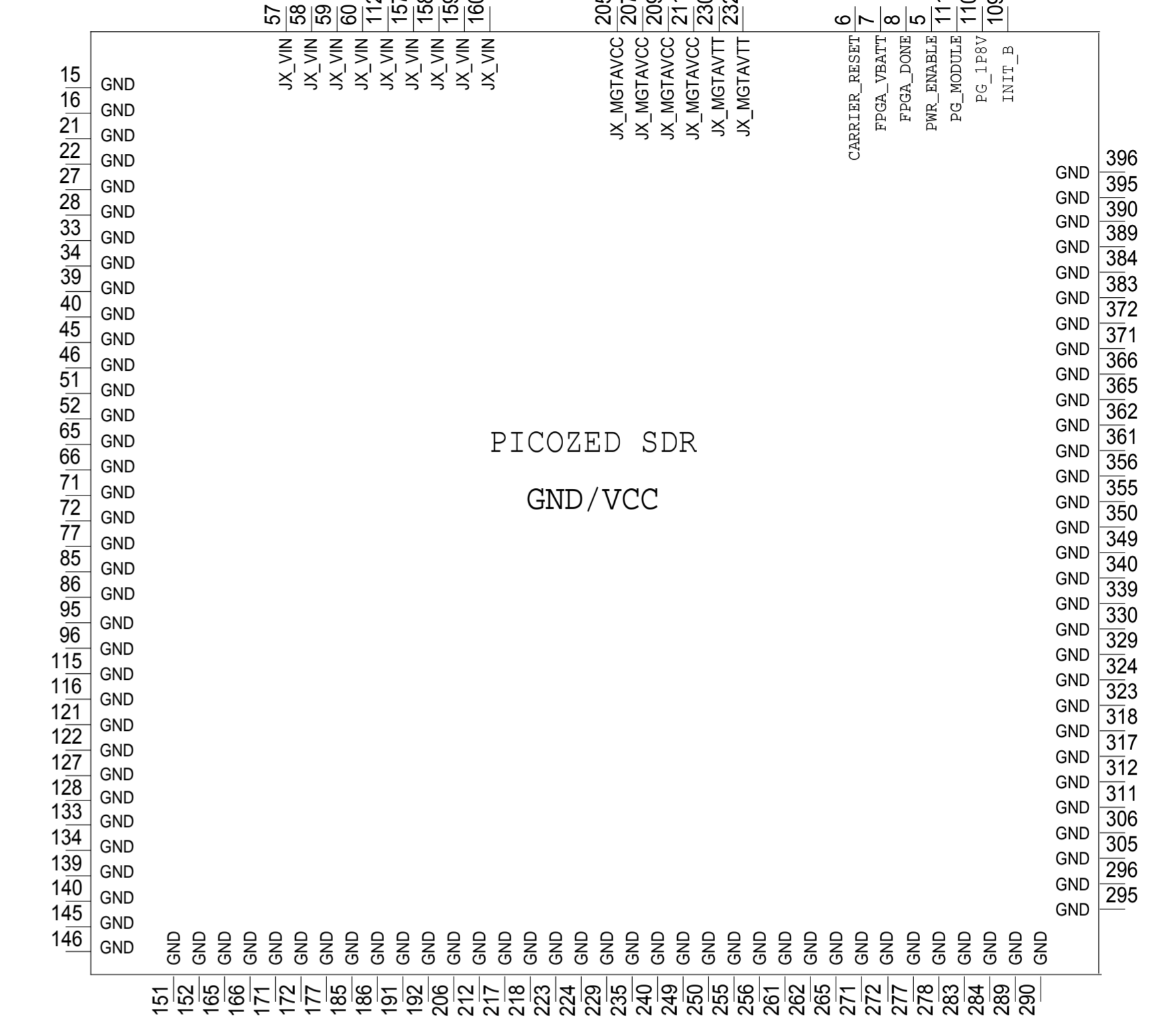
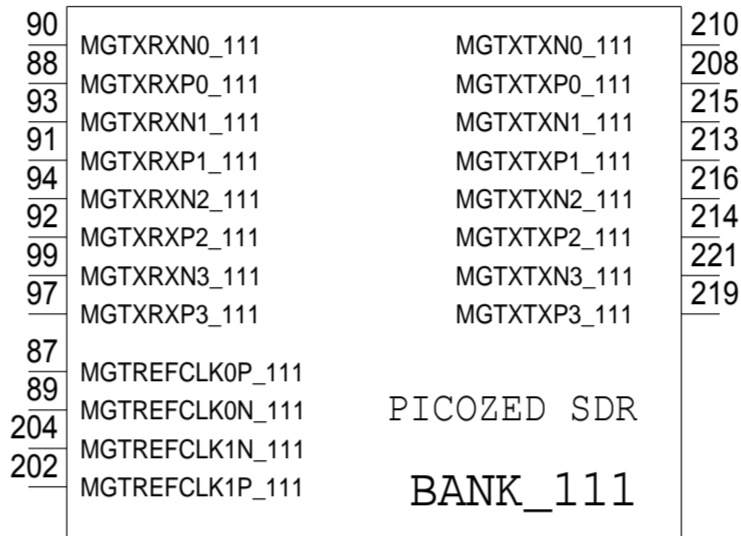
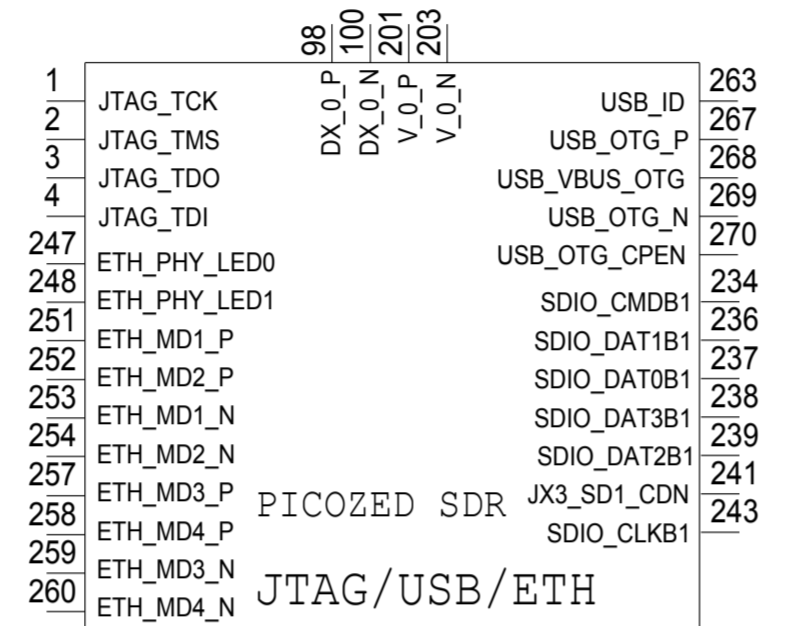
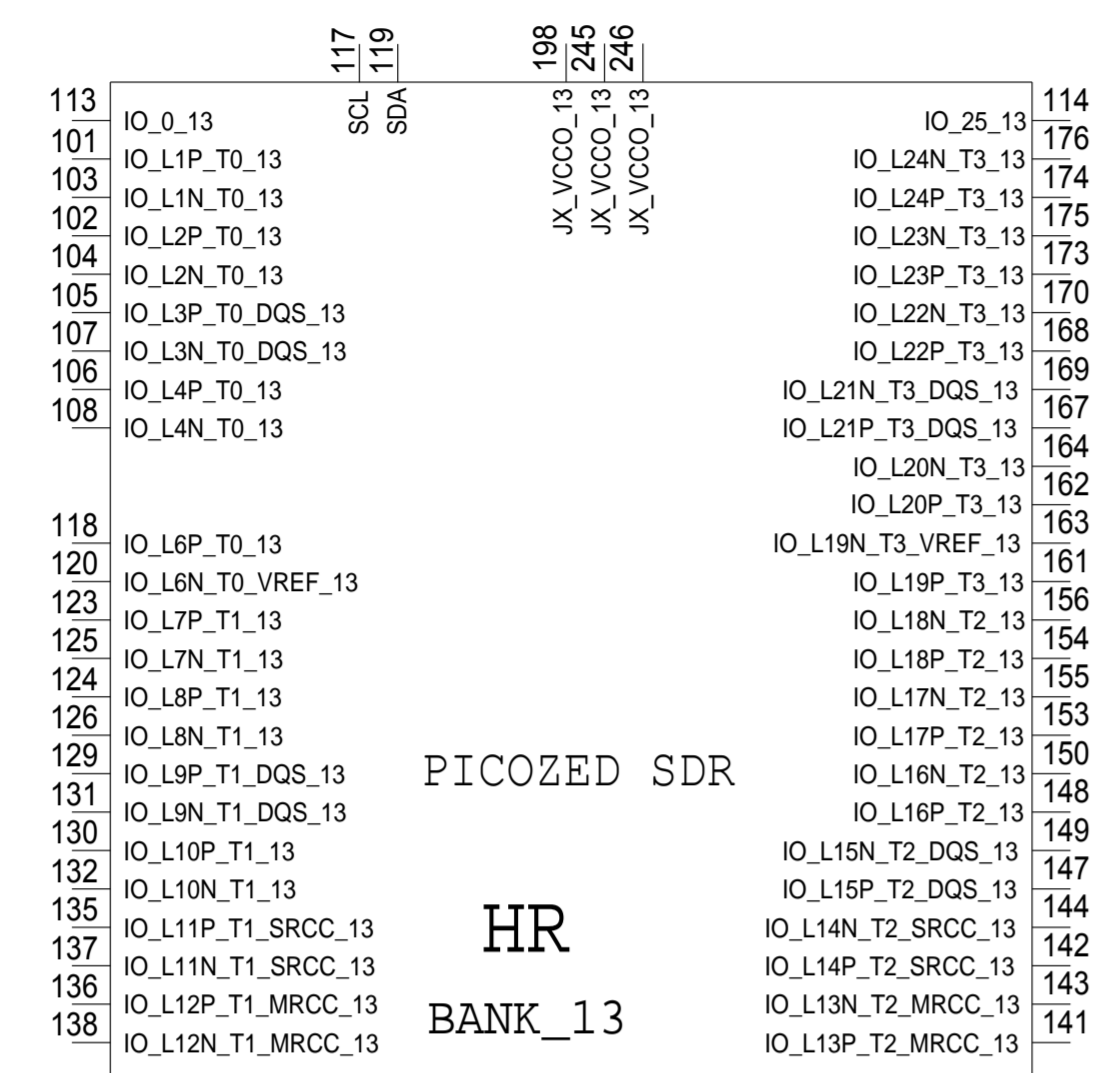

	SCHEMATIC		
	HW TYPE : PICOZED CDR CONNECTOR Product (s):		
DESIGN VIEW <DESIGN_VIEW>	DRAWING NO.		REV
PTD ENGINEER <PTD_ENGINEER>	SIZE D	SCALE 1:1	SHEET 7 OF 10